



## Features

### **Eco-Friendly Refrigerant**

R290 refrigerant with a global warming potential (GWP) of 3

### **Easy to Clean**

Aluminum interior, coved corners, finished edges, and removable shelves

### **High-Strength Door**

Heavy-duty, stainless steel door assembled using high-load brackets for long lasting durability

### **Long-Lasting, Removable Gaskets**

Santoprene™ gaskets last four times longer than standard gaskets

### **High-Density Insulation**

Foamed-in-place, CFC-free polyurethane insulation for maximum strength, rigidity, and insulation

### **High-Efficiency Refrigeration System**

Forced air circulation provides uniform temperature throughout the cabinet

### **Cabinet Capacity**

Internal area of 5.5ft<sup>3</sup> with two (2) heavy-gauge wire shelves — adjustable in 1/2" increments using stainless steel pilasters

### **Heavy-Duty Soft Casters**

Secured to a 12 gauge steel base to ensure years of worry-free operation

### **Stainless Steel Exterior**

Galvanized back and bottom to reduce the risk of corrosion

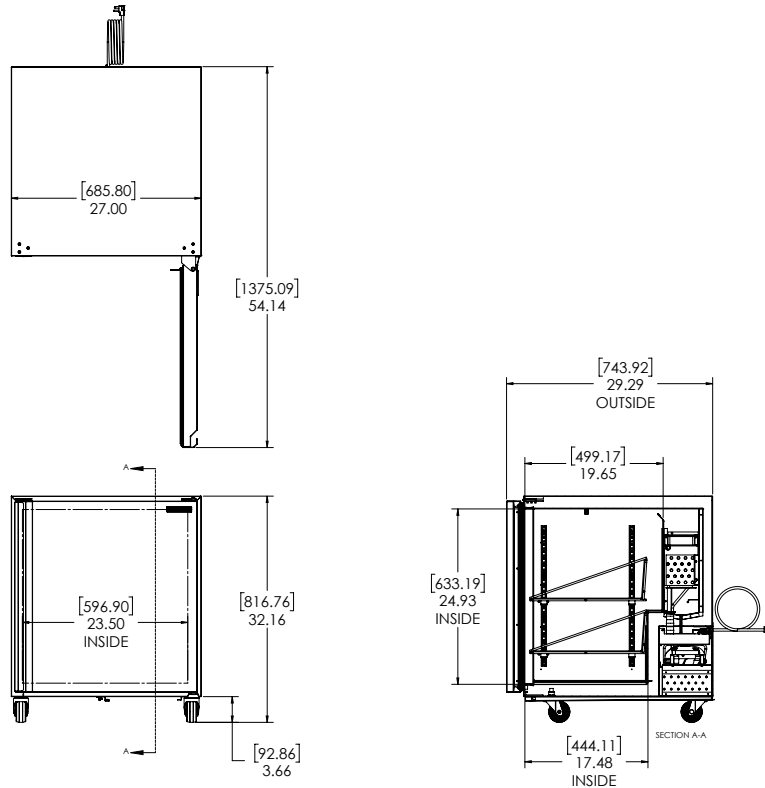

## Technical Specifications

<b>Electrical Requirements</b>	115v/60hz/1ph/1.6A/NEMA 5-15P Plug
<b>Product Dimensions</b>	27"W x 32.15"H x 29.32"D (68.58cm x 81.66cm x 74.47cm)
<b>Product Weight</b>	145lbs (65.77kg)
<b>Shipping Dimensions</b>	32"W x 40"H x 37"D (81.28cm x 101.60cm x 93.98cm)
<b>Shipping Weight</b>	160lbs (72.57kg)
<b>Shipping Cubic Dimensions</b>	27.41ft <sup>3</sup> (.78m <sup>3</sup> )
<b>Temperature Range</b>	36 to 38 (2.22 to 3.33°C)
<b>Refrigerant</b>	R290
<b>Charge Level</b>	3.8oz (108 grams)

<b>Insulation</b>	Foamed-in-place, CFC-free polyurethane
<b>Exterior Construction</b>	Stainless steel exterior with galvanized back and bottom
<b>Interior Construction</b>	Aluminum interior with coved corners and finished edges
<b>Doors</b>	One (1) left-hand swing door
<b>Interior Capacity</b>	5.5ft <sup>3</sup>
<b>Door/Drawer Gasket</b>	Santoprene™ gasket
<b>Shelves</b>	Two (2) heavy-gauge wire shelves
<b>Casters</b>	Four (4) 3" heavy-duty soft casters (two locking)
<b>Certifications</b>	ETL Safety, ETL Sanitation
<b>Warranty</b>	1-year parts and labor, 5-year compressor (part only)

Model Number	Description
SKR27A-ESUS2	Undercounter Refrigerator 27", 115v/60hz/1ph, single left-hand swing door, 3" heavy-duty casters (two locking), NEMA 5-15P

To learn more about **Undercounter Refrigerator**, visit [silverking.com](http://silverking.com)